

QUALITY

INTELLIGENT DESIGN  
EXCELLENCE  
PARTNERSHIP

INTEGRATED SOLUTIONS

Q-SAFE RANGE  
QUICK COUPLINGS

 **manuli**<sup>®</sup>  
HYDRAULICS

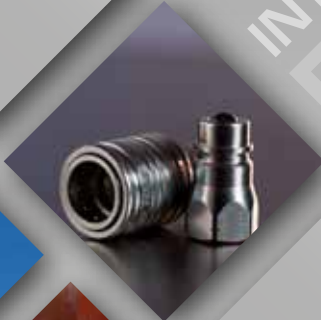
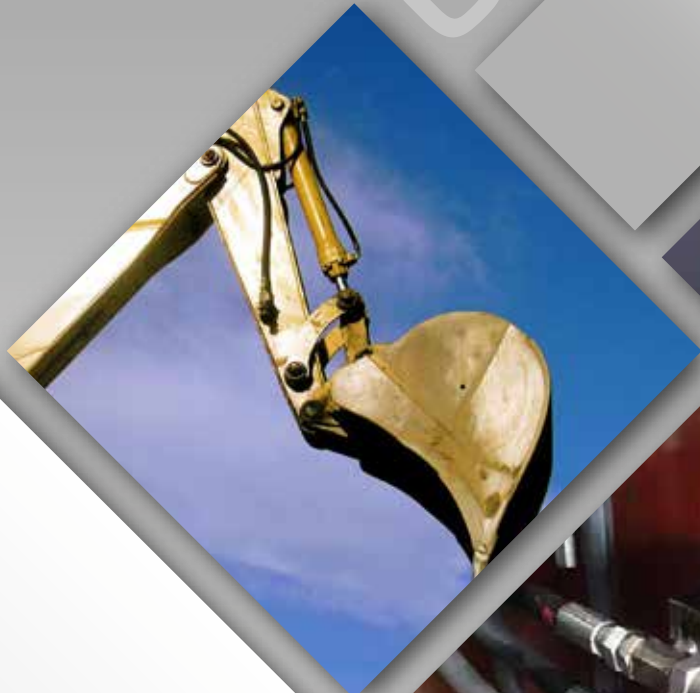

# Why Manuli?

*Manuli Hydraulics is focused on achieving excellence in the design, manufacture and supply of fluid conveyance solutions, components and associated equipment for high pressure hydraulics, refrigeration and oil and marine applications.*

# Rugged solutions

*Modern hydraulic system specific solutions to*

*Quality and sustainable development are the driving forces of all Manuli Hydraulics' activities, with an aim to guarantee worldwide availability of technical and commercial support for its products and services.*



## An integrated approach

Modern hydraulics applications require robust fluid connector solutions with guaranteed long lasting performance. To that end, Manuli Hydraulics offers a complete range of hoses, fittings and assembly equipment which are designed to work seamlessly together. This harmonised approach allows us to guarantee the quality and performance of hose assemblies in a way that our competitors simply cannot match.

From design to manufacture and assembly, our commitment to this unified philosophy makes us the global leader in providing integrated solutions for hydraulic connector applications.



## Solutions for the toughest applications

Systems are required to deal with ever more challenging applications, environments and conditions. The Manuli Extreme range has been specifically designed to provide the most robust solutions for the toughest hydraulic applications.



 **manuli**<sup>®</sup>  
HYDRAULICS

# Q.Safe

## Q.Safe for General Hydraulics

*Q.Safe is the Manuli Hydraulics offering accessories and spare parts, the Q.Safe*

### Why Quick Couplings?

Modern hydraulic equipment is often designed to carry out multiple tasks with just a simple change of tooling. This trend is particularly prevalent in the agriculture and construction industries, where tractors, skid steer loaders, back hoes, telescopic handlers and excavators are typically equipped with auxiliary hydraulic lines to allow the attachment of any of a multitude of different tools.

In order to facilitate quick, safe and repeated connection a suitable coupling for the hydraulic feed and return lines must be used.

Some key requirements of these couplings are:

- High working pressure and safety factor
- Minimal pressure drop across the coupling
- Minimal oil spillage on connection / disconnection
- Low connection / disconnection effort
- Connection under pressure



# Hydraulic Applications

For quick coupling applications. Composed of more than 1,200 references, the Q.Safe brand has rapidly become an industry byword for quality and performance.



The entire Q.Safe product range is manufactured with an environmentally friendly Cr3+ (trivalent chrome) surface coating, which offers excellent resistance to corrosion; far exceeding ISO 4520 requirements (salt spray resistance: 240 hours for white corrosion and 400 for red corrosion). Guaranteeing leak-free performance, the Q.Safe brand is suitable for a wide range of different applications and assures total interchangeability with other quick coupling products on the market.

All Q.Safe products are manufactured and assembled in our world-class facility in Poland, where they are subjected to stringent quality controls including:

- 100% visual check
- 100% functional test
- 100% air sealing test



# Q.Safe Flat Face Program

One of the cornerstones of the *Manuli Extreme* product range, the Q.Safe range of flat face couplings was developed with one clear goal in mind - to push the boundaries of what can be achieved by production model quick couplings.

Thus the Flat Face Program from Manuli was conceived.

The Q.Safe Flat Face program is comprised of four distinct flat valve models:

- **MQS-F** - Flat face coupling
- **MQS-FH** - High pressure flat face coupling
- **MQS-FP** - Flat face coupling with male connectable under pressure
- **MQS-FS** - Screw type flat face coupling

Each model has been designed to our uniquely high specifications, ensuring that it provides the best possible performance in whatever application it is used for.



Pressure Drop for MQS-F Series

- Competitor 1 Equivalent Quick Coupling (DN12)
- Competitor 2 Equivalent Quick Coupling (DN12)
- Competitor 3 Equivalent Quick Coupling (DN12)
- Manuli Hydraulics Flat Face Quick Coupling (DN12)

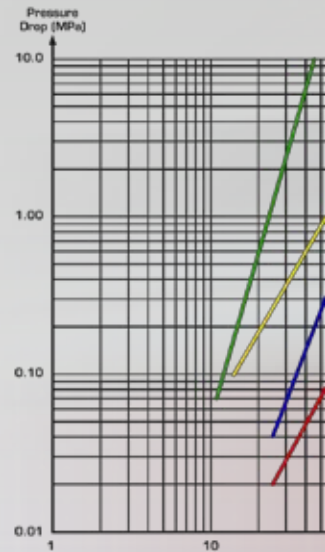

SIZE	WORKING PRESSURE - CONNECTED (Dynamic)	WORKING PRESSURE - DISCONNECTED (Dynamic)	RATED FLOW at 0.2 MPa of pressure drop	CONNECTION EFFORT	OIL SPILLAGE Connection/Disconnection	MINIMUM BURST PRESSURE	CONNECTION/DISCONNECTION UNDER PRESSURE
6.3	35	25	15	130	0.005	160	Not allowed
10	35	25	53	130	0.007	140	Not allowed
12.5	35	25	98	140	0.008	135	Not allowed
16	35	25	109	150	0.008	150	Not allowed
19	35	25	174	210	0.009	110	Not allowed
25	35	21	203	230	0.02	100	Not allowed

mm	inch	dash	MPa		PSI		l/min	US GPM	N	lb.	cc.	cubic inch	Male		Female		M & F		Connection/Disconnection Under Pressure
			MPa	PSI	MPa	PSI							MPa	PSI	MPa	PSI			
6.3	1/4	04	35	5075	35	5075	15	4.0	130	29.2	0.005	0.0003	160	23200	140	20300	150	21750	Not allowed
10	3/8	06	35	5075	25	3625	53	14.0	130	29.2	0.007	0.0004	140	20300	125	18125	145	21025	Not allowed
12.5	1/2	08	35	5075	25	3625	98	25.9	140	31.5	0.008	0.0005	135	19575	115	16675	145	21025	Not allowed
16	5/8	10	35	5075	25	3625	109	28.8	150	33.7	0.008	0.0005	150	21750	100	14500	140	20300	Not allowed
19	3/4	12	35	5075	25	3625	174	46.0	210	47.2	0.009	0.0005	110	15950	102	15225	145	21025	Not allowed
25	1	16	35	5075	21	3045	203	53.6	230	51.7	0.02	0.0012	100	14500	85	12325	150	21750	Not allowed

MQS-F technical data

# MQS-F - Flat Face Coupling

As baseline products go, the MQS-F flat face coupling sets a whole new standard for the quick release coupling industry.

With global interchangeability, high pressure ratings and the lowest pressure drop profile on the market, the MQS-F is a product that our competitors can only aspire to.

**The MQS-F coupling provides the following benefits:**

- Streamlined inner profile provides market-leading pressure drop performance at high flow rates
- Environmentally friendly Cr3+ (Trivalent Chrome) coating with 400+ hours to red rust under salt spray conditions
- WP of up to 25 MPa (disconnected) and 35 MPa (connected) with a safety factor of 4:1 in all states
- Moulded polyurethane (PU) seal on male coupling
- Almost zero oil spillage during connection / disconnection
- Made from highly resistant materials with selective tempering on most stressed areas
- Working temperature range from -30°C to +110°C (-22°F to +230°F)
- Globally interchangeable according to ISO 16028
- Tested to 1,000,000 cycles at 120% of working pressure
- No oil contamination during connection / disconnection
- Low connection / disconnection effort

vs. Flow Rate  
vs. Competitors

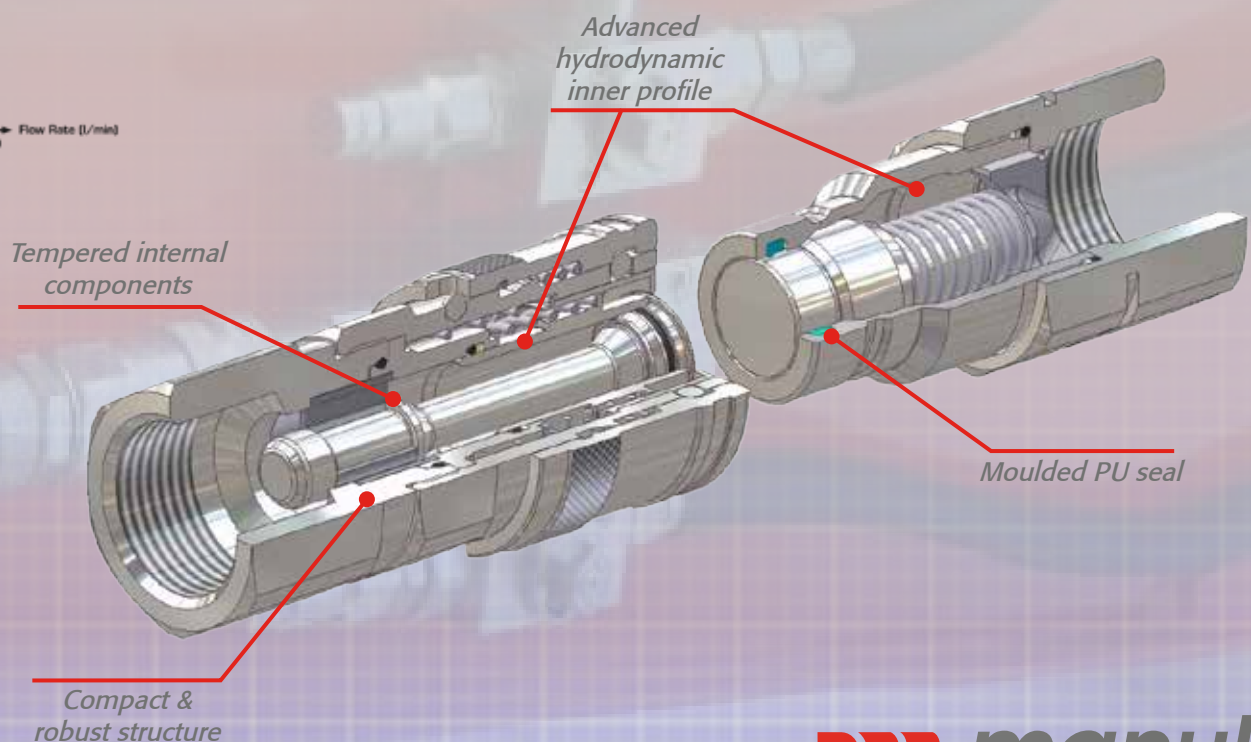
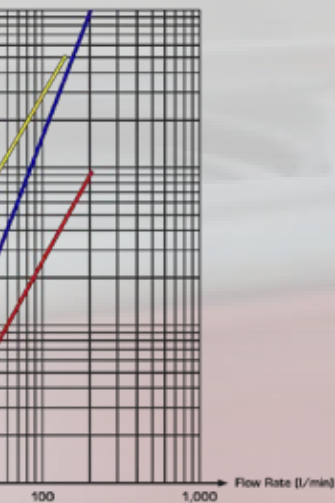

# MQS-FH - High Pressure Flat Face Coupling

**Designed for continuous service in high-pressure applications, the MQS-FH series couplings have an even more robust outer structure and higher resistance internal components.**

In addition to the properties of the standard MQS-F series, the MQS-FH series also has the following benefits:

- Increased service life in heavy-duty applications
- WP of 35 MPa in both connected and disconnected conditions
- Improved energy efficiency
- More robust construction
- Enhanced polyurethane (PU) seal





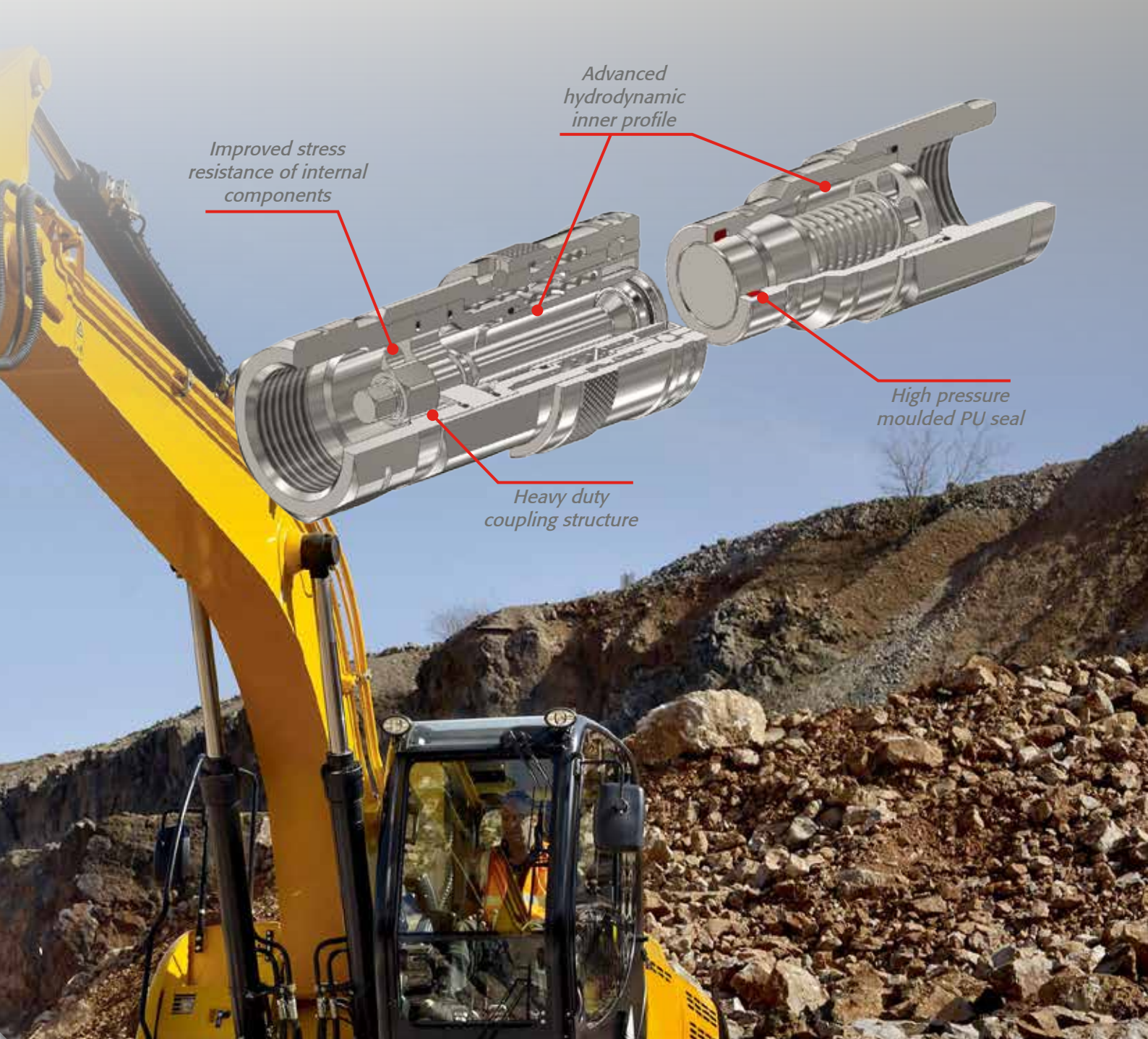







Improved stress resistance of internal components

Advanced hydrodynamic inner profile

Heavy duty coupling structure

High pressure moulded PU seal

							
SIZE	WORKING PRESSURE - CONNECTED (Dynamic)	WORKING PRESSURE - DISCONNECTED (Dynamic)	RATED FLOW at 0.2 MPa of pressure drop	CONNECTION EFFORT	OIL SPILLAGE Connection/Disconnection	MINIMUM BURST PRESSURE	CONNECTION/DISCONNECTION UNDER PRESSURE

mm	inch	dash	MPa		PSI		l/min	US GPM	N	lb.	cc.	cubic inch	Male		Female		M & F		
			MPa	PSI	MPa	PSI							MPa	PSI	MPa	PSI			
6.3	¼	04	See MQS-F																
10	¾	06	35	5075	35	5075	44	11.6	130	29.2	0.007	0.0004	150	21750	140	20300	170	24650	Not allowed
12.5	½	08	35	5075	35	5075	84	22.2	140	31.5	0.008	0.0005	140	20300	140	20300	160	23200	Not allowed
16	¾	10	35	5075	35	5075	108	28.5	150	33.7	0.008	0.0005	140	20300	160	23200	160	23200	Not allowed
19	¾	12	35	5075	35	5075	148	39.1	210	47.2	0.009	0.0005	140	20300	140	20300	160	23200	Not allowed
25	1	16	35	5075	35	5075	224	59.2	230	51.7	0.02	0.0012	140	20300	140	20300	160	23200	Not allowed

MQS-FH technical data







# MQS-FP - Connect Under Pressure Flat Face Coupling

Often used on earth-moving machine implements, the MQS-FP can be connected / disconnected the male coupling under full working pressure. This is achieved by the addition of a micro valve and a mini polyurethane seal, creating a triple valve system.

In addition to the properties of the standard MQS-F series, the MQS-FP series also has the following benefits:

- Ability to be connected with the male coupling at full working pressure of 35 MPa (female must be at 0 MPa)
- WP of 35 MPa in both connected and disconnected conditions
- Low connection effort even when male coupling is pressurised



							
SIZE	WORKING PRESSURE - CONNECTED (Dynamic)	WORKING PRESSURE - DISCONNECTED (Dynamic)	RATED FLOW at 0.2 MPa of pressure drop	CONNECTION EFFORT	OIL SPILLAGE Connection/ Disconnection	MINIMUM BURST PRESSURE	CONNECTION/ DISCONNECTION UNDER PRESSURE

mm	inch	dash	MPa	PSI	MPa	PSI	l/ min	US GPM	N	lb.	cc.	cubic inch	Male		M & F		
													MPa	PSI	MPa	PSI	
10	3/8	06	35	5075	35	5075	56	14.8	150	33.7	0.007	0.0004	170	24650	140	20300	Connection allowed
12.5	1/2	08	35	5075	35	5075	85	22.5	180	40.5	0.008	0.0005	170	24650	140	20300	Connection allowed
16	5/8	10	35	5075	35	5075	99	26.2	200	45.0	0.008	0.0005	170	24650	140	20300	Connection allowed
19	3/4	12	35	5075	35	5075	131	34.6	200	45.0	0.009	0.0005	140	20300	150	21750	Connection allowed
25	1	16	35	5075	35	5075	170	44.9	220	49.5	0.02	0.0012	140	23200	160	23200	Connection allowed

MQS-FP technical data





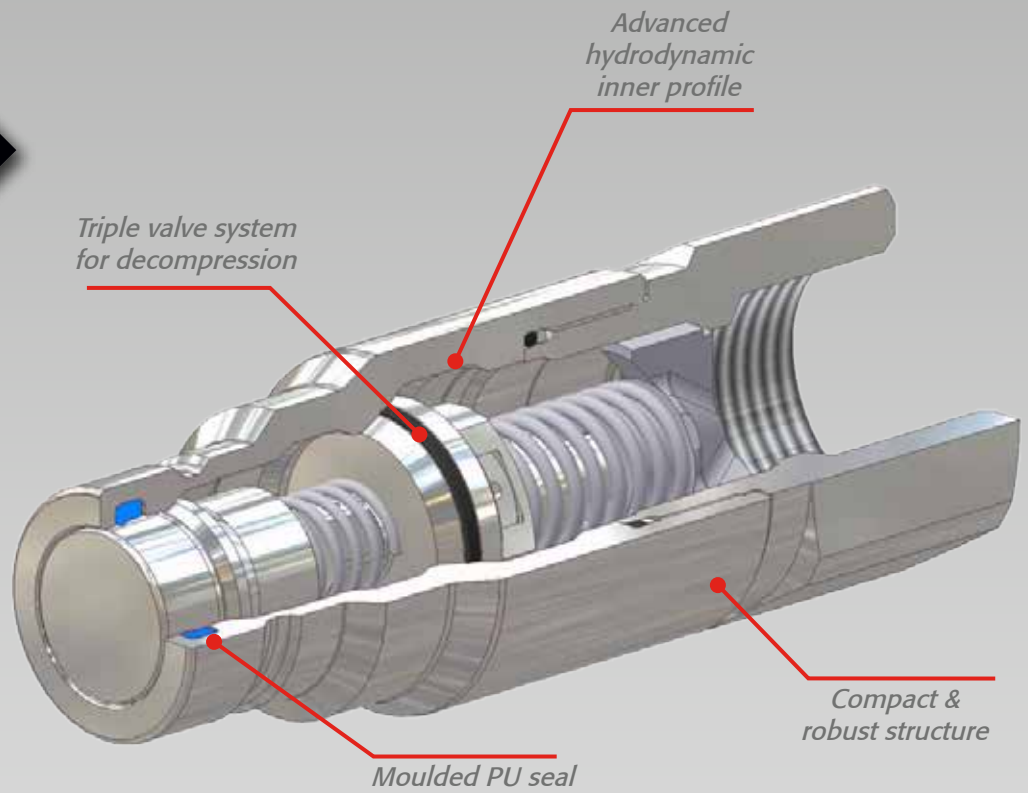

ng

d with  
e with a

efits:





							
SIZE	WORKING PRESSURE - CONNECTED (Dynamic)	WORKING PRESSURE - DISCONNECTED (Dynamic)	RATED FLOW at 0.2 MPa of pressure drop	TIGHTENING TORQUE	OIL SPILLAGE Connection/ Disconnection	MINIMUM BURST PRESSURE	CONNECTION/ DISCONNECTION UNDER PRESSURE

mm	inch	dash	MPa		PSI		l/ min	US GPM	Nm	cc.	cubic inch	Male		Female		M & F		
			MPa	PSI	MPa	PSI						MPa	PSI	MPa	PSI	MPa	PSI	
10	3/8	06	35	5075	35	5075	43	11.4	60	0.007	0.0004	160	23200	140	20300	170	24650	Allowed
12.5	1/2	08	35	5075	35	5075	70	18.5	100	0.008	0.0005	170	24650	150	21750	150	21750	Allowed
16	5/8	10	35	5075	35	5075	85	22.5	100	0.008	0.0005	200	29000	160	23200	160	23200	Allowed
19	3/4	12	35	5075	35	5075	135	35.7	150	0.009	0.0005	145	21025	145	21025	160	23200	Allowed
25	1	16	35	5075	35	5075	170	44.9	200	0.02	0.0012	145	21025	145	21025	160	23200	Allowed
38	1 1/2	24	32	4640	32	4640	396	104.6	400	0.05	0.0031	130	18850	130	18850	130	18850	Allowed

MQS-FS technical data

# MQS-FS - Screw Type Flat Face Coupling

Incorporating the best design features of the rest of the flat face series, the MQS-FS is the quintessential coupling of its type. Ruggedly built, but sacrificing none of the hydrodynamic excellence inherent in the rest of the Q-Safe flat face range, the MQS-FS is the ultimate choice for even the most severe of applications,

In addition to the properties of the standard MQS-F series, the MQS-FS series also has the following benefits:

- Ability to be connected with both couplings at full working pressure of 35 MPa
- WP of 35 MPa in both connected and disconnected conditions
- Screw coupling for minimal connection effort even when system is pressurised
- Enhanced polyurethane moulded seal
- Extremely robust construction making it suitable for the toughest applications

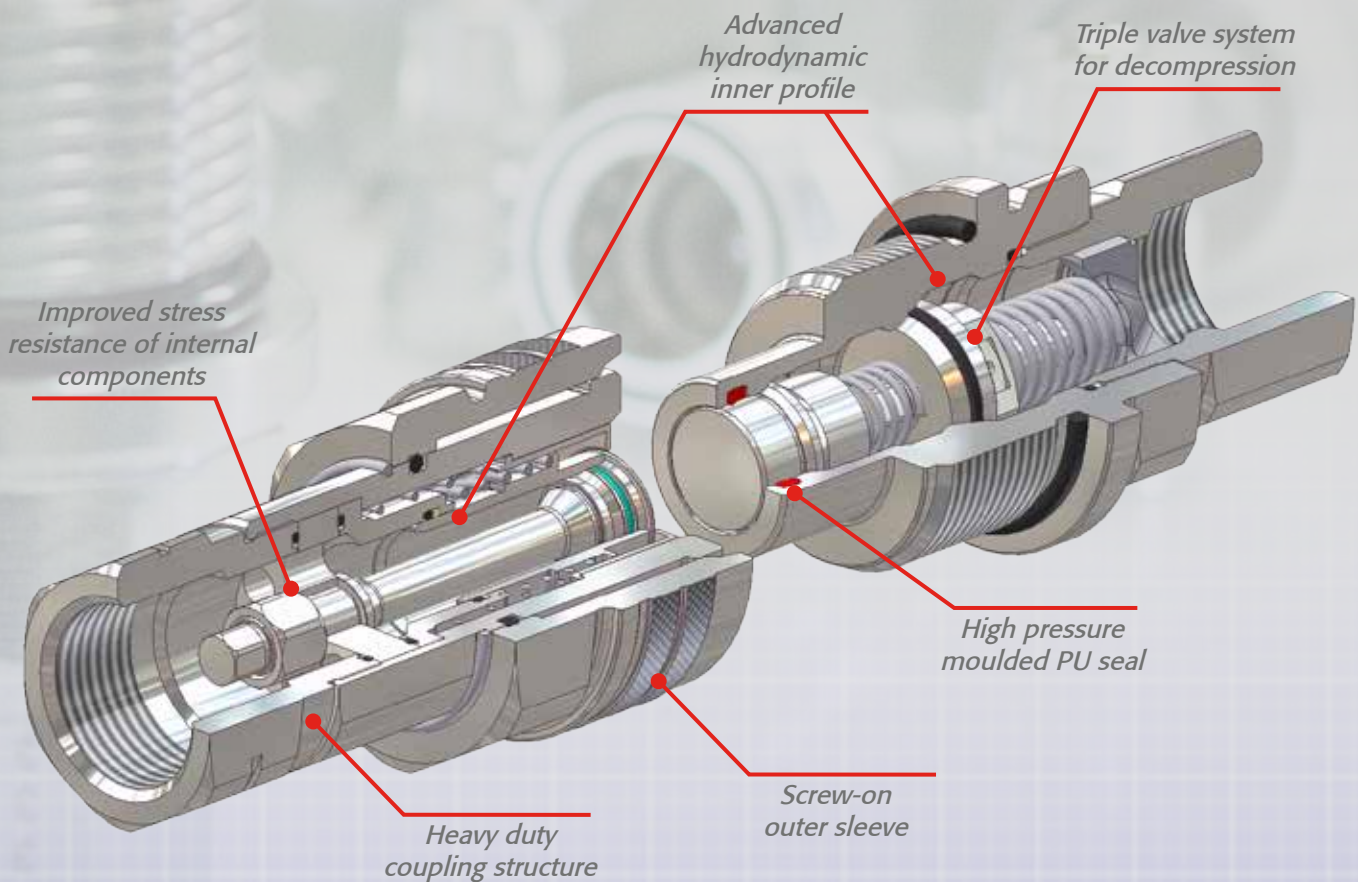

# Q.Safe Flat Face Multiconnectors

*The Q.Safe quick coupling range is widely renowned for representing the Gold Standard in quick coupling quality and performance. The introduction of the Q.Safe Flat Face Multiconnector range combines this superior performance with the added efficiency and safety related benefits of a multiconnector block system.*

## Q.Safe Multiconnector Benefits:

- Reduces connection time when multiple connectors are used
- No risk of incorrect connection
- No misalignment between mobile and static blocks
- Compact design for minimal added weight
- Flat face couplings allow high pressures (350 bar) and high flow rates
- Allows hoses to be arranged closer together whilst still allowing easy access
- Industry leading performance with reduced pressure drop
- Almost zero (between 0.007cc and 0.009cc) oil spillage on connection / disconnection
- Connection under residual pressure
- Easy to clean

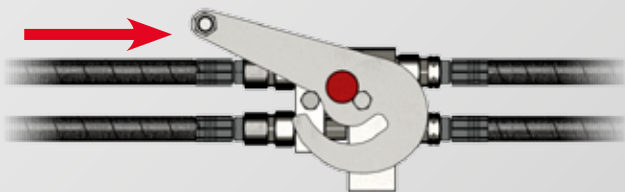
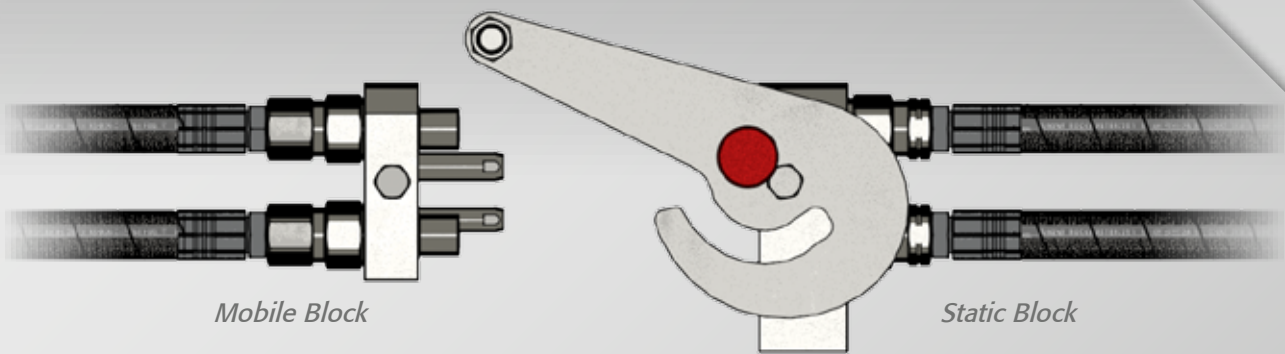

Simply position the mobile block so that the couplings sit against the face of the static block. The extended pins will slide into the mating holes to ensure perfect alignment.

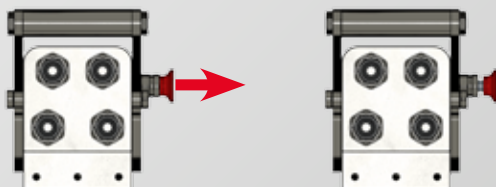



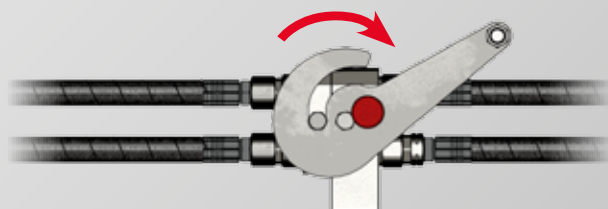

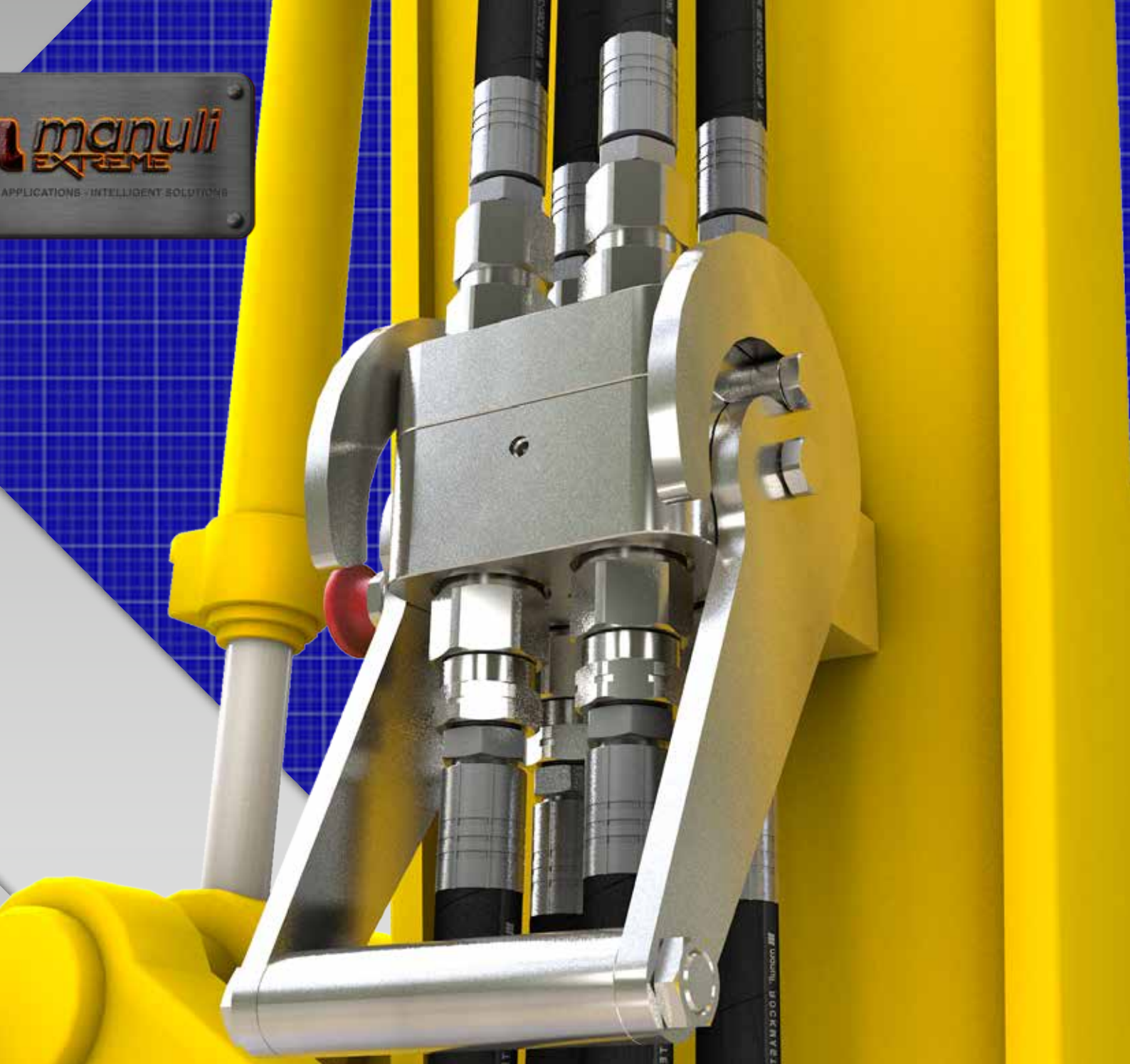

Pull out the red locking pin to allow the handle to move.



Move the handle in the direction shown to pull the mobile block towards the static block, making the connection with the couplings. The red pin will pop back in when the connection is complete, effectively locking the two parts together.



						
SIZE	WORKING PRESSURE - CONNECTED (Dynamic)	WORKING PRESSURE - DISCONNECTED (Dynamic)	RATED FLOW at 0.2 MPa of pressure drop	OIL SPILLAGE Connection/ Disconnection	MINIMUM BURST PRESSURE	CONNECTION/ DISCONNECTION UNDER PRESSURE

mm	inch	dash	MPa		PSI		l/ min	US GPM	cc.	cubic inch	Male		Female		M & F		
			MPa	PSI	MPa	PSI					MPa	PSI	MPa	PSI			
10	3/8	06	35	5075	35	5075	45	11.9	0.007	0.0004	160	23200	140	20300	180	26100	Allowed
12.5	1/2	08	35	5075	35	5075	75	19.8	0.008	0.0005	170	24650	150	21750	180	26100	Allowed
19	3/4	12	35	5075	35	5075	125	33.0	0.009	0.0005	145	21025	145	21025	160	23200	Allowed

Q.Safe multiconnector flat face coupling technical data

# The Best of the Rest - MQS-ARM & MQS-ARB

*The MQS-ARM and MQS-ARB are amongst the most advanced non-flat face couplings on the market. Compatible with all standard ISO A male couplings, these products are designed especially for rigid mounting on agricultural vehicles.*







## The MQS-ARM coupling provides the following benefits:

- Working pressure up to 30 MPa
- Connectable with male coupling under pressure
- Push-pull connection disconnection
- Breakaway function according to ISO 5675
- Safety factor of 4:1 for dynamic pressures
- Tested to 500,000 cycles at 120% of WP

## The MQS-ARB coupling also provides the following additional benefit:

- Connectable with both couplings under pressure



						
<b>SIZE</b>	<b>WORKING PRESSURE (Dynamic)</b>	<b>RATED FLOW at 0.2 MPa of pressure drop</b>	<b>CONNECTION EFFORT</b>	<b>OIL SPILLAGE Connection/ Disconnection</b>	<b>MINIMUM BURST PRESSURE</b>	<b>CONNECTION/ DISCONNECTION UNDER PRESSURE</b>

mm	inch	dash	MPa	PSI	Flow direction	l/min	US GPM	N	lb.	cc.	cubic inch	Female		M & F		
												MPa	PSI	MPa	PSI	
12.5	½	08	30	4350	F → M	80	21.1	230	511	2.1	0.128	125	18125	125	18125	Connection only, with male under pressure
					M → F	68	18.0									

MQS-ARM technical data

12.5	½	08	30	4350	F → M	80	21.1	230	511	2.5	0.153	125	18125	125	18125	Connection only, with male and female under pressure
					M → F	68	18.0			With 0 MPa of pressure						

MQS-ARB technical data



# DHI - Direct to Hose Integration







*The Q.Safe DHI program from Manuli Hydraulics is an innovative system allowing the quick coupling to be assembled directly to the hose.*

Assembly of the quick coupling directly to the hose provides a number of important benefits over the more typical adaptor style fittings.

- Fewer components in the hose assembly reduces the cost of assembly operations and parts
- Reduced number of components also minimises the number of potential leak points
- Reduced risk of assembly operation mistakes
- Easier maintenance and replacement operations
- Quick coupling maintenance is possible without the need to replace the hose
- Eliminates unscrewing problems in the field

DHI solutions are available for ISO A, ISO B and flat face series



						
<b>SIZE</b>	<b>WORKING PRESSURE (Dynamic)</b>	<b>RATED FLOW at 0.2 MPa of pressure drop</b>	<b>CONNECTION EFFORT</b>	<b>OIL SPILLAGE Connection/ Disconnection</b>	<b>MINIMUM BURST PRESSURE</b>	<b>CONNECTION/ DISCONNECTION UNDER PRESSURE</b>

mm	inch	dash	MPa	PSI	l/min	US GPM	N	lb.	cc.	cubic inch	Male		Female		M & F		Not allowed
											MPa	PSI	MPa	PSI	MPa	PSI	
12.5	½	08	30	4350	75	19.8	80	18.0	1.8	0.110	125	18125	150	21750	150	21750	Not allowed

*DHI ISO A technical data*

12.5	½	08	30	4350	68	18.0	110	244	2	0.122	140	20300	140	20300	-	-	Not allowed
------	---	----	----	------	----	------	-----	-----	---	-------	-----	-------	-----	-------	---	---	-------------

*DHI ISO A push-pull technical data*

6.3	¼	04	40	5800	16	4.3	40	9.0	0.8	0.049	180	26100	190	27550	165	23925	Not allowed
10	¾	06	35	5075	51	13.5	40	9.0	1.5	0.092	145	21025	160	23200	160	23200	Not allowed
12.5	½	08	35	5075	84	22.0	70	15.7	2.5	0.153	145	21025	145	21025	160	23200	Not allowed

*DHI ISO B technical data*

10	¾	06	25	3625	53	14.0	130	29.2	0.007	0.0004	140	20300	125	18125	145	21025	Not allowed
12.5	½	08	25	3625	98	25.9	140	31.5	0.008	0.0005	135	19575	115	16675	145	21025	Not allowed

*DHI flat face technical data*



QUICK COUPLINGS SERIES	SHUT-OFF SYSTEM	SPECIFICATIONS	CONNECTION	SIZE																
				1/8"	1/4"	3/8"	1/2"	5/8"	3/4"	1"	1 1/4"	1 1/2"	2"							
MQS-SG Screw	Poppet Valve	German Market interchangeable ISO 14541 (from 3/8" to 3/4")	Screw-on Sleeve																	
MQS-SGR Screw heavy duty	Poppet Valve	German Market interchangeable ISO 14541 (from 3/8" to 3/4")	Screw-on Sleeve																	
MQS-SH Screw heavy duty	Poppet Valve	French Market interchangeable	Screw-on Sleeve																	
MQS-SC Screw hydraulic cylinders	Poppet Valve & Ball Valve	ISO 14540	Screw-on Sleeve																	
MQS-ST Screw for truck	Poppet Valve	-	Screw-on Sleeve																	
MQS-SS Stainless Steel	Poppet Valve	ISO 7241 series B	Locking Balls																	
	Flat Valve	ISO 16028 e HTMA (only 3/8" size)	Locking Balls																	
	Poppet Valve	French Market interchangeable	Screw-on Sleeve																	

### Q.Safe DHI Product Range

QUICK COUPLINGS SERIES	SHUT-OFF SYSTEM	SPECIFICATIONS	CONNECTION	SIZE																
				1/8"	1/4"	3/8"	1/2"	5/8"	3/4"	1"	1 1/4"	1 1/2"	2"							
MQS-DHI ISO A	Poppet Valve	ISO 7241 SERIES A	Locking Balls																	
MQS-DHI ISO A push-pull	Poppet Valve	ISO 7421 SERIES A	Locking Balls																	
MQS-DHI ISO B	Poppet Valve	ISO 7241 SERIES B	Locking Balls																	
MQS-DHI Flat-face	Flat Valve	ISO 16028 e HTMA	Locking Balls																	

### Q.Safe Multiconnector Product Range

MULTICONNECTOR SERIES	NO. OF LINES	SIZE		
		3/8"	1/2"	3/4"
SERIES 01	2			
SERIES 02	2			
SERIES 03	4			
SERIES 04	4			
SERIES 05	2			
SERIES 06	4			
SERIES 07	6			
SERIES 08	6			
SERIES 09	8			
SERIES 10	4			

Contact your local Manuli Hydraulics representative to find out more about the Q.Safe product range and how it can meet all your quick coupling requirements



[www.manuli-hydraulics.com](http://www.manuli-hydraulics.com)

*© Copyright 2016 Manuli Hydraulics. All rights reserved.  
All product names are either trademarks or registered trademarks of  
Manuli Hydraulics or Manuli Rubber Industries unless otherwise stated.*



Global Sales & Marketing Office, Suite 9a 111 Piccadilly, Manchester, M1 2HY, UK  
Tel: +44 (0)161 871 1130; Email: [marketing@manuli-hydraulics.com](mailto:marketing@manuli-hydraulics.com)